

0/ 0



For Sales & Service questions please
contact your dealer:

Your local dealer is:

B

LOGIX™ SERIES INSTALLER QUICK-START SHEET	3
MANUAL OVERVIEW	7
How To Use This Manual	7
EQUIPMENT INSTALLATION	8
General Warnings And Safety Information	8
Valve Features	11
Location Selection	13
Water Line Connection	14
Drain Line Connection	16
Overflow Line Connection	17
Regenerant Line Connection	18
Electrical Connection	20
Valve Camshaft	21
SYSTEM DISINFECTION	23
Disinfection Of Water Conditioners	23
DETERMINING IF YOU HAVE A 740 OR 760 CONTROL	24
GENERAL 700 SERIES INSTRUCTIONS	25
DISPLAY ICONS 700 CONTROLLER	
KEYPAD — Buttons	28
Regeneration Modes	29
740/760 Series Initial Power-Up	30
Initial Start-up Step-By-Step Instructions	31
PLACING CONDITIONER INTO OPERATION (turning on the water)	34
PROGRAMMING THE 700 FOR 5-CYCLE FILTER APPLICATIONS	37
Manganese Greensand Systems	37
700 Series Advanced Programming	39
Resetting the Logix Control	40
740/760 PROFESSIONAL PROGRAMMING	41
VALVE SERVICE	43
Cover	43
Electronic Control Module	43
Drive Motor	44
Optical Sensor	45
Camshaft	46
Wiring Harnesses	48
Microswitch (Optional Under the Cover)	49
Microswitch (Optional - Front of Camshaft)	50
Spring (Valve Discs)	51
Relay (Optional)	52
Terminal Block (Optional)	53
Transformer (Optional)	53
Top Plate	54
PARTS AND ACCESSORIES	56
255 Valve Exploded View	56
255 Valve Parts List	57
Performa Exploded View	59
Performa Parts List	608(st)-21340.8(6)-1



See *Determining If You Have a 740 or 760 Control* on page 24 to identify your controller.

0 ~~Electronic time clock control capable of doing~~ 7-day (day of week) regeneration, or up to a 99 interval day regeneration. This control will operate both in a conditioner (softener) or 3-cycle filter mode with the same controller.

0 ~~Electronic metered demand (volumetric) controller which~~ regenerates based on the water usage of the installation site. A calendar override is a standard feature on this controller.

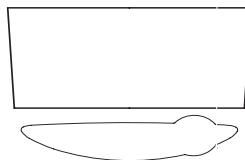

- At initial power-up, the camshaft will need to rotate to the HOME (in service) position.
- Camshaft may take 1-2 minutes to return to home position.
- Err 3 will be displayed until the camshaft returns to home.
- If more than 2 minutes elapses, verify that the motor is turning the camshaft. If it is not turning, see the troubleshooting section.

- Use the UP or DOWN buttons to change to the number of days desired.
- Press SET to accept the regen frequency, and advance to the next cycle.

- Set desired regenerant amount.
- Default setting is "S" standard salting.
- 3 salt settings are available on 740 and 760 controls:
 - S – Standard Salt – 9 lbs/cubic foot of resin (120 grams/liter of resin)
 - H – High Salt – 15 lbs/cubic foot of resin (200 grams/liter of resin)
 - L – Low Salt – 3 lbs/cubic foot of resin (40 grams/liter of resin)
- Low Salt is the "Highly Efficient Mode".
- To change salt setting, press the SET button and use the UP and DOWN buttons to change to the desired setting.
- Press SET to accept the setting and advance to the next parameter.

See *Dealer Installation Manual* for more complete information on salt settings for different system sizes, capacities and expected efficiencies.

- System capacity is displayed in total kilograins or kilograms of hardness removed before a regeneration is necessary.
- Value is derived from the system's resin volume input, and salt amount input.
- The capacity displayed is a suggested value - as recommended by resin manufacturers.
- Capacity is only displayed for information purposes on 740 control - it does not (and cannot) need to be changed.
- To change capacity on 760 control, press SET to make the default capacity flash. Use the UP and DOWN buttons to increment to the desired capacity.
- Press SET to accept the setting and advance to the next parameter.

- Press REGEN once for delayed regeneration.
System will regenerate at next set regen time (2:00 AM).
A flashing regen (recycle) symbol will be displayed.
 - Press and hold REGEN for 5 seconds to initiate immediate manual regeneration. A solid regen symbol will be displayed.
 - After immediate regeneration has begun, press REGEN again to initiate a second manual regeneration. An X2 symbol will be displayed, indicating a second regeneration will follow the first regeneration.
-
- A "C#" is displayed to show current cycle.
 - Total regen time remaining is displayed on screen.



This installation manual is designed to guide the installer through the process of installing and starting conditioners featuring the 700 Logix series



▶ W ▶ 9 ▶ ▶ ▶ ▶

- Observe all warnings that appear in this manual.
- Keep the media tank in the upright position. Do not turn on side, upside down, or drop. Turning the tank upside down will cause media to enter the valve.
- Operating ambient temperature is between 34°F (1°C) and 120°F (49°C).
- Operating water temperature is between 34°F (1°F) and 100°F (38°C).
- Working water pressure range is 20 to 120 psi (1.38 to 8.27 bar). In

The control directs water down through the resin bed and up through the riser tube to the drain. Any remaining brine residual is rinsed from the resin bed.

B

Brine refill occurs during a portion of the fast rinse cycle. Water is directed to the regenerant tank at a controlled rate, to create brine for the next regeneration.

Figure 1

SERVICE BACKWASH BRINE/SLOW RINSE

FAST RINSE

Figure 2
255 Valve Identification

Figure 3
Performa Valve Identification

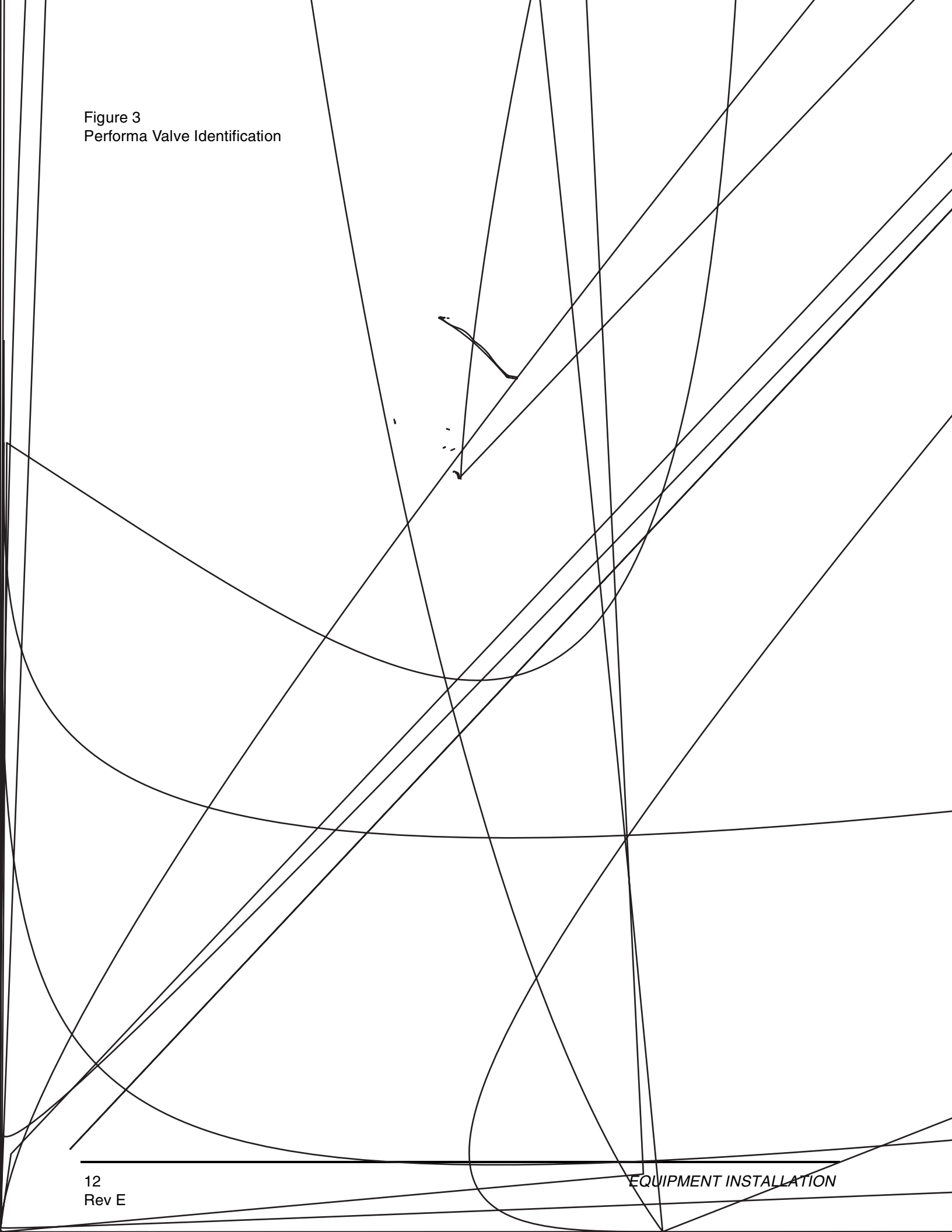

Figure 4
700 Series Controller Identification



Location of a water treatment system is important. The following conditions are required:

- Level platform or floor
- Room to access equipment for maintenance and adding regenerant (salt) to tank.
- Ambient temperatures over 34°

When the water conditioning system is installed outdoors, several items must be considered.

- Moisture — The valve and controller are rated for NEMA 3 locations. Falling water should not affect performance. The system is not designed to withstand extreme humidity or water spray from above. Examples are: condensation, rain, or spray from a sprinkler.
- Direct Sunlight — The materials used will fade or discolor over time in direct sunlight.
- Wind

W 1 / 1 . 00 . 1 . 1 1 . 1 0.00 0.01 \

Figure 5
Series 256 bypass for use with 255 valve body

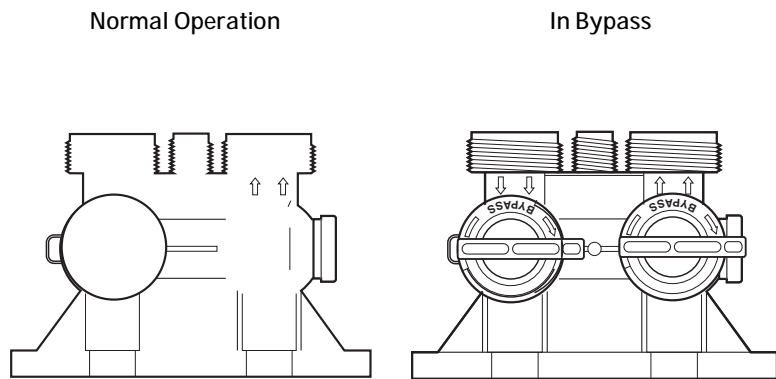

Figure 6
Series 1265 bypass for use with Performa valve bodies

Figure 7
Typical Globe Valve Bypass System



W · The inlet water must be connected to the inlet port of the valve. When replacing non-Pentair Water valves, the inlet and outlet may be reversed. It is also possible for the plumbing to be installed in an opposite order.
Do not solder pipes with lead-based solder.



W · Do not use tools to tighten plastic fittings. Over time, stress may break the connections. When the 1265 or 256 bypass valve is used, only hand tighten the plastic nuts.

W · Do not use petroleum grease on gaskets when connecting bypass plumbing. Use only 100% silicone grease products when installing any plastic valve. Non-silicone grease may cause plastic components to fail over time.



· Standard commercial practices are expressed here. Local codes may require changes to the following suggestions. Check with local authorities before installing a system.

1. The unit should be above and not more than 20 feet (6.1 m) from the drain. Use an appropriate adapter fitting to connect 1/2-inch (1.3 cm) plastic tubing to the drain line connection of the control valve.
2. If the backwash flow rate exceeds 5 gpm (22.7 Lpm) or if the unit is located 20-40 feet (6.1-12.2 m) from drain, use 3/4-inch (1.9 cm) tubing. Use appropriate fittings to connect the 3/4-inch tubing to the 3/4-inch NPT drain connection on valve.
3. The drain line may be elevated up to 6 feet (1.8 m) providing the run does not exceed 15 feet (4.6 m) and water pressure at the conditioner is not less than 40 psi (2.76 bar). Elevation can increase by 2 feet (61 cm) for each additional 10 psi (.69 bar) of water pressure at the drain connector.
4. Where the drain line is elevated but empties into a drain below the level of the control valve, form a 7-inch (18-cm) loop at the far end of the line so that the bottom of the loop is level with the drain line connection. This will provide an adequate siphon trap.

Where the drain empties into an overhead sewer line, a sink-type trap must be used.

Secure the end of the drain line to prevent it from moving.

Figure 8
Drain Line Connection



In the event of a malfunction, the regenerant TANK OVERFLOW will direct

Figure 9
Overflow Line Connection



The regenerant line from the tank connects to the valve. Make the connections and hand tighten. Be sure that the regenerant line is secure and free from air leaks. Even a small leak may cause the regenerant line to drain out, and the conditioner will not draw regenerant from the tank. This may also introduce air into the valve causing problems with valve operation.

Most installations utilize a tank check valve. This is not necessary when using the 255 valve with the built-in aircheck. Using a tank check valve with the 255 valve with aircheck will result in premature checking of the aircheck valve, before the tank is empty.

Figure 10
Air Check for 255 valve

Figure 11
Regenerant Connection for
Performa Valve

· When installing a 3-cycle filter (253 or 263 valve) use a cap on the regenerant line connection to prevent water seepage from the port. See *Parts and Accessories* section for part number.

An aircheck must be used in the regenerant line when installing a Performa valve.

Figure 12
 Regenerant Tank Check Valve (not provided)*

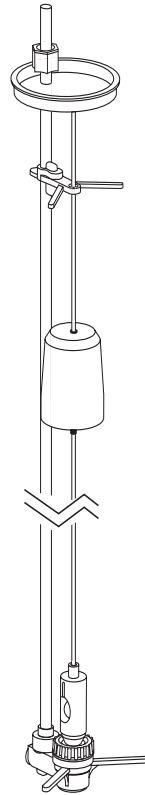

* Furnished as an option from conditioner system manufacturer.

This valve and control are for dry location use only unless used with a Listed Class 2 power supply suitable for outdoor use.

All 700 Series controllers operate on 12-volt alternating current power supply. This requires use of the supplied AC adapter. A variety of AC adapters are available for different applications. These AC adapters are available from your supplier. They include:

Standard wall-mount AC adapter	120V 60Hz	Standard indoor application	1000811
Outdoor rated AC adapter	120V 60Hz	UL listed for outdoor installations	1235448
International option AC adapters	Varies based on country	Standard indoor application	See Parts Lists Section

100 , 1 0 ▶ 0

Make sure power source matches the rating printed on the AC adapter.

The 700 Series controller is available in two power configurations. The North American controller operates on 60 Hz. If the incoming power is 50 Hz, the "North American" controller will not function. The error code "ERR 2" will show on the display.

The "World" controller will sense the input power as 50 or 60 Hz and operate accordingly.

The 700 Series controllers are designed to be mounted on the valve or attached to a flat surface. Installations that do not provide easy access to the valve can have the controller mounted for remote operation.

A remote mount connection, P/N 1256257, is available for the 700 Series

Regeneration Cycle Indicators

- C0 = Treated Water - normal operation mode
- C1 = Backwash Cycle
- C2 = Regenerant Draw Cycle (not used in filter mode)
- C3 = Slow Rinse Cycle (not used in filter mode)
- C4 = System Pause

▶ ▶ W ▶ ▶

The materials of construction of the modern water conditioner will not support bacterial growth, nor will these materials contaminate a water supply. During normal use, a conditioner may become fouled with organic matter, or in some cases with bacteria from the water supply. This may result in an off-taste or odor in the water.

Some conditioners may need to be disinfected after installation and some conditioners will require periodic disinfection during their normal life.

Depending upon the conditions of use, the style of conditioner, the type of ion exchanger, and the disinfectant available, a choice can be made among the following methods.

These materials are satisfactory for use with polystyrene resins, synthetic gel zeolite, greensand and bentonites.

. %

These solutions are available under trade names such as Clorox*. If stronger solutions are used, such as those sold for commercial laundries, adjust the dosage accordingly.

1. Dosage
 - A. Polystyrene resin; 1.2 fluid ounce (35.5 ml) per cubic foot.
 - B. Non-resinous exchangers; 0.8 fluid ounce (23.7 ml) per cubic foot.
2. Brine tank conditioners
 - A. Backwash the conditioner and add the required amount of hypochlorite solution to the well of the regenerant tank. The regenerant tank should have water in it to permit the solution to be carried into the conditioner.
 - B. Proceed with the normal regeneration.

**Clorox is a trademark of the Clorox Company.*

Calcium hypochlorite, 70% available chlorine, is available in several forms including tablets and granules. These solid materials may be used directly without dissolving before use.

1. Dosage
 - A. Two grains (approximately 0.1 ounce [3 ml]) per cubic foot.
2. Regenerant tank conditioners
 - A. Backwash the conditioner and add the required amount of hypochlorite to the well of the regenerant tank. The regenerant tank should have water in it to permit the chlorine solution to be carried into the conditioner.
 - B. Proceed with the normal regeneration.

00

The 700 Series controllers feature battery-free time and date retention during the loss of power. This is designed to last a minimum of 8 hours depending on the installation. The controller will continue to keep time and day in dynamic memory while there is no AC power.

The controller will not track water usage on volumetric demand controls in the event of a power failure.

All programmed parameters are stored in the 700 Series static memory and will not be lost in the event of a power failure. These settings are maintained

▶ ▶

The 700 Series metered-demand volumetric controllers (760 and 760C) are designed to have a variable reserve feature. This feature automatically adjusts the reserve to the end-user's water usage schedule.

A variable reserve saves salt and water by only regenerating when absolutely necessary, and ensures enough soft water for typical high-water usage days.

Each day of regeneration the controller reviews the last four weeks of water usage for the same day of the week to determine if the remaining capacity is adequate for the next day of the week. If the remaining capacity is not adequate, it will initiate an automatic regeneration.

Figure 17

1. Days of the week. The flag immediately below the day will appear when that day has been programmed as a day the system should regenerate (used with 7-day timer programming).
2. See #3
3. This cursor is displayed when the days between regeneration are being programmed (used with .5 to 99 day regeneration programming).
4. One of these cursors will be displayed to indicate which day will be programmed into the controller.
5. "PM" indicates that the time displayed is between 12:00 noon and 12:00 midnight (there is no AM indicator). PM indicator is not used if clock mode is set to 24-hour.
6. When "MIN" is displayed, the value entered is in minute increments.
7. When "Kg" is displayed, the value entered is in kilograms or kilograins.
8. Four digits used to display the time or program value. Also used for error codes.
9. Colon flashes as part of the time display. Indicates normal operation.
10. Locked/unlocked indicator. In Level I program-15.rh (-15.r(c)-6.[(10.kCol)8(o)0.51]-15.

14. The display cursor is next to "REGEN TIME & DAY" when programming the time of regeneration and the days of regeneration.
15. The display cursor is next to "TIME & DAY" when programming the current time and day.
16. The hourglass is displayed when the motor is running. The camshaft should be turning.
17. These cursors will appear next to the item that is currently displayed.
18. X100 multiplier for large values.
19. Shows when water is flowing through the valve.
20. Used with #24, #25, and #26. Displays a sequence number or a value.
21. History Values (H). The number displayed by #23 identifies which history value is currently displayed.
22. Parameter (P). Displayed only in Level II Programming. The number displayed by #23 identifies which parameter is currently displayed.
23. Cycle(C). The number displayed by #23 is the current cycle in the regeneration sequence.
24. Hardness setting—only used with 760 and 760C controllers.
25. Capacity display—shows estimated system capacity.

B ▶

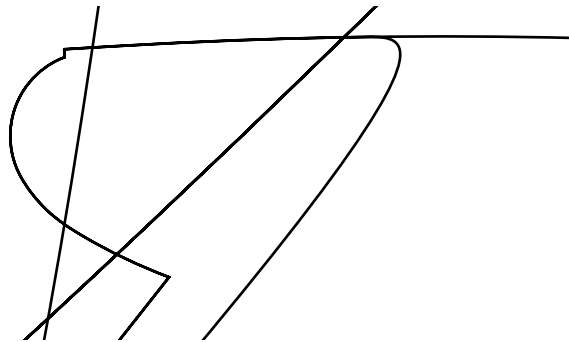

1. DOWN arrow. Generally used to scroll down or increment through a group of choices.
2. SET. Used to accept a setting that normally becomes stored in memory. Also used together with the arrow buttons.
3. UP arrow. Generally used to scroll up or increment through a group of choices.
4. Regenerate. Used to command the controller to regenerate. Also used to change the lock mode.

- Press and hold SET - showing current cycle time.
- Simultaneously press SET and UP to advance on cycle. An hourglass will display while cam is advancing. When cam reaches next cycle, "C2" will be displayed.
- Repeat SET and UP to advance through each cycle.
- Press and hold SET and UP for 5 seconds to cancel regen. Hourglass will flash once cancelled. Camshaft will advance to home – may take 1 to 2 minutes.

- C1 – Backwash
- C2 – Regeneration Draw/Slow Rinse (not used in filter mode)
- C3 – Slow Rinse (not used in filter mode)
- C4 – System Pause (to repressurize tank)
- C5 – Fast Rinse cycle 1
- C6 – Backwash cycle 2 (not used in filter mode)
- C7 – Fast Rinse cycle 2 (not used in filter mode)
- C8 – Regenerant Refill (not used in filter mode)

0/ 0

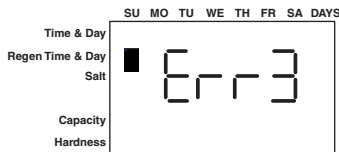

- At initial power-up, the camshaft may need to rotate to the HOME (in service position).
- Camshaft may take 1 to 2 minutes to return to HOME position.
- Err 3 will be displayed until the camshaft returns to HOME position.
- If more than 2 minutes elapses, verify that the motor is turning the camshaft. If it is not turning, contact Dealer.



The 700 Series controller features a self-test sequence. At first power-up of the control, you may see a number such as 1.00, 1.02, 1.04, or 2.00 displayed. This is an indication that the self-test is not completed. To complete the test, verify that the turbine cable is connected. Blow air into the turbine port (valve outlet) to spin the turbine. The controller will verify that the turbine works and the self-test will finish. Proceed with the initial start-up procedure.

B

For FA filter applications, please program as normal below. See section *Programming the 700 for 5-Cycle Filter Applications*.

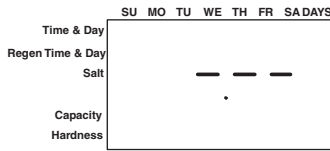

1 9

This step may have been performed by your system's OEM manufacturer. In this case, proceed to step 2.



Capacity is the result of the amount of media in the tank and the salt setting. The default capacity will be changed by selecting a different regenerant setting.

3-cycle filter

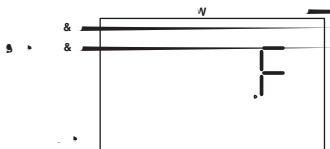

- Input system size – media volume (For FA filters, choose your closest media volume) – in cubic feet or liters.
- Use UP and DOWN buttons to scroll through resin volume choices.
- Choose the nearest volume to your actual system size.
- To choose a 3-cycle filter operation – press DOWN until an “F” is displayed.
- Press SET to accept the system size you've selected.
- If incorrect setting is programmed, see “Resetting the Control” section below.



If the controller was incorrectly set to the wrong valve body, press the DOWN button and SET button for five seconds to display resin volume in "HO". Press and hold the SET button for five seconds to reset the controller. Use the UP or DOWN buttons to increment the display to the correct valve body. Press SET.



9

- While “12:00” is blinking, set the correct time of day.
- Use the UP and DOWN buttons to scroll to the correct time of day.
- “PM” is indicated, “AM” is not indicated.
- Press SET to accept the correct time of day and advance to the next parameter.

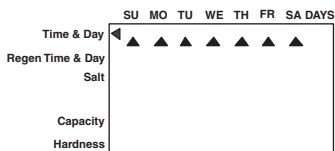

W <

- Press SET to make the arrow under “SU” flash.
- Use the UP and DOWN buttons to advance the arrow until it is under the correct day of week.
- Press SET to accept and advance to the next parameter.

1

- 
- 2:00 (AM) is the default time of regeneration. To accept this time, press the DOWN button to move to step 5.
 - To change the regen time, press SET – causing “2:00” to flash.
 - Use the UP and DOWN buttons to advance to the desired regen time.
 - Press SET to accept the time and advance to the next parameter.



0



B

If the system is set up as a filter, the regenerant amount is unnecessary. The controller deactivates the regenerant amount setting, and changes to an adjustable backwash time in minutes.

- Press SET to change the time.
- The default time of 14 minutes will begin to flash.
- Use UP and DOWN to select the appropriate backwash time for the media type and amount used. The controller can use 0 to 99 minutes for backwash.
- Press SET again to enter that time.

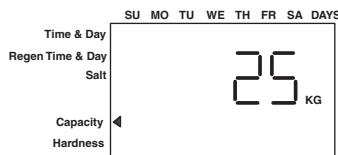

- System capacity is displayed in total kilograins or kilograms of hardness removed before a regeneration is necessary.
- Value is derived from the system's resin volume input and salt amount input.
- The capacity is displayed for information purposes on the 740 control. It cannot be changed.
- To change capacity on the 760 control, press SET to make the default capacity flash. Use the UP and DOWN buttons to increment to the desired capacity.
- Press SET to accept the setting and advance to the next parameter.

If using the 740 control, programming is complete. The control will return you to the normal operation mode.

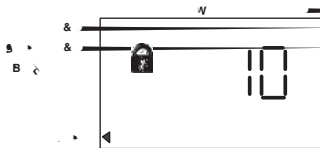

- Enter inlet water hardness at installation site.
- Default hardness setting is 10 grains (ppm for metric).
- To change hardness, press SET to make the setting flash. Use the UP and DOWN buttons to scroll to the desired hardness.
- Press SET to accept the entered hardness value.
- The control will return you to the normal operation mode.

Initial programming is now complete. The control will return to normal operation mode if a button is not pushed for 30 seconds.

For system start-up procedure, including: purging the mineral tank, refilling the regenerant tank, and drawing regenerant, see the system start-up procedure in the *Dealer Installation and Service Manual*.

If the tank has a salt platform in the bottom of the tank, add water until the water level is approximately 1 inch (25 mm) above the platform.

6. Engage the refill cycle to prime the line between the regenerant tank and

hose connections. C2 should be displayed.

8. If the water level is receding from the regenerant tank you can then advance the controller back to the treated water (C0) position by pressing SET and the UP buttons simultaneously to advance the controller to the C0 position.
9. Finally, turn on a faucet plumbed after the water conditioner. Run the faucet until the water runs clear. Add regenerant to the regenerant tank.

- When the controller is first plugged in, it may display a flashing hourglass and the message Err 3, this means that the controller is rotating to the home position. If the Err 2 is displayed, check that the incoming power frequency matches the controller. The North American controller will not run with 50 Hz input.
- The preset default time of regeneration is 2:00 AM.
- English or Metric? The World controller senses the electrical input and decides which is needed. The North American controller only runs on 60 Hz and defaults to English units.
- The 700 Series controller can be programmed to regenerate on specific days of the week.
- If electrical power is not available, the camshaft can be rotated counterclockwise by hand if the motor is removed.
- The 700 Series controllers send commands to the motor for camshaft movement. However, water pressure/flow are required during the regeneration cycle for backwash, purge and refill, and brine draw to actually take place.
- Make sure control power source is plugged in. The transformer should be connected to a non-switched power source.
- You can start programming at the beginning by resetting the amount of media. When viewing H0 (History Value) push and hold SET for five seconds. The display reverts back to and any programmed information is lost. Return to *700 Series Initial Power Up*.

Potassium permanganate regenerating iron filters should be sized for the appropriate backwash and injector sizes.

B Be sure to choose the appropriate backwash flow rate control (see *Parts* section) as recommended by your media manufacturer.

Enter basic programming	SET	Press and Release	Will show day of week
Move to desired display	UP or DOWN arrows	Press and Release	Will increment through the displays
Enable setting to be changed	SET	Press and Release	Display will flash
Change setting	UP or DOWN arrows	Press and Release	Value changes and continues to flash
Save setting	SET	Press and Release	Display stops flashing
Return to operation	REGEN	Press and Release	Normal operation display
View history values	SET and DOWN	Press and Hold for 5 seconds	HO will be displayed

This level of programming is accessible by pressing the SET button. The UP and DOWN arrows will step through the settings:

Time of day

Day of week

Time of regeneration

Number of days between regeneration (99 day timer)

Day of week regeneration (displays only when number of days between regeneration equals zero) (7 day timer)

Amount of regenerant used per regeneration or filter backwash time

System capacity (view only)

9

The Logix control features a review level that displays the operation history of



· If a button is not pushed for thirty seconds the controller returns to normal operation mode. Pushing the UP and DOWN arrows for 5 seconds returns the controller to normal operation.



· Any setting that is a time display will not show "AM" for times between 12:00 midnight and 12:00 noon. "PM" is displayed to the right of the time for times between 12:00 noon and 12:00midnight. When using the 24-hour clock, "PM" is not displayed.

In this level all of the programming features of basic programming are available. In addition, the settings can be locked/unlocked.

A setting that is locked will display a lock icon when viewed in the basic level.

A locked setting is viewable in the basic programming menus but it cannot be changed.

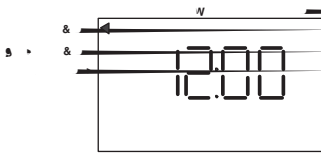

When viewing a setting in this level the display will show a "P" value. This corresponds to the displayed setting.

Level II menus include:

P1 = Time of day

P2 = Day of week

P3 = Time of regeneration

P4 = Number of days between regeneration

P5 = Not used

P6 = Amount of regenerant used per regeneration or filter backwash time

P7 = System capacity

P8 = Hardness

P9 = Units of measure

P10 = Clock mode



The cover provides protection for the controller, wiring, and other components. This cover will be removed for most service and maintenance. When installed, the cover provides NEMA 3 water protection. This protects from falling water up to 30 degrees from vertical.

1. Grasp side edges toward rear of the valve.
2. Pull outwards until the slots in the cover clears the projections on the top plate.
3. Lift up on the rear and pull forward to clear the control module.

1. Position cover to be low in front and under the bottom edge of the control module.
2. The cover will hook on the bottom of the controller and drop down over the camshaft.
3. To finish, grasp the side edges and pull outward to clear the projections on the top plate.
4. Drop down until the cover snaps in place.

The purpose of the electronic control module is to control the regeneration cycle. The control module has several variations. When replacing the controller, use the same model or some functions may not work. This is an electronic controller that is programmable and uses input/output signals.

1. Disconnect power to the unit.
2. Remove valve cover.
3. Press trip lever to release module from top plate.
4. Pivot the top forward and up.
5. Remove any wire connections. Wire connectors have a locking tab that must be squeezed before removing.

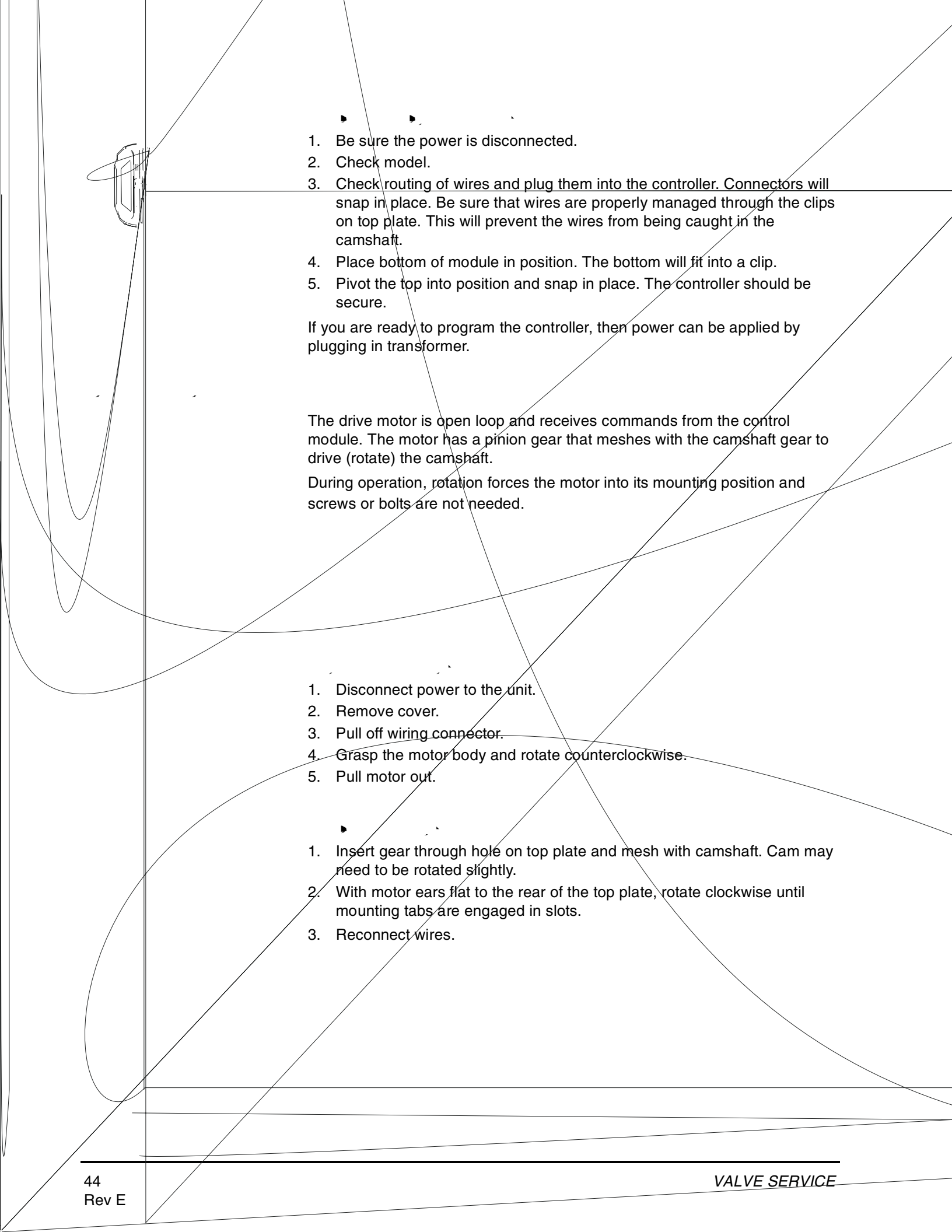
- 
1. Be sure the power is disconnected.
 2. Check model.
 3. Check routing of wires and plug them into the controller. Connectors will snap in place. Be sure that wires are properly managed through the clips on top plate. This will prevent the wires from being caught in the camshaft.
 4. Place bottom of module in position. The bottom will fit into a clip.
 5. Pivot the top into position and snap in place. The controller should be secure.

If you are ready to program the controller, then power can be applied by plugging in transformer.

The drive motor is open loop and receives commands from the control module. The motor has a pinion gear that meshes with the camshaft gear to drive (rotate) the camshaft.

During operation, rotation forces the motor into its mounting position and screws or bolts are not needed.

1. Disconnect power to the unit.
2. Remove cover.
3. Pull off wiring connector.
4. Grasp the motor body and rotate counterclockwise.
5. Pull motor out.

1. Insert gear through hole on top plate and mesh with camshaft. Cam may need to be rotated slightly.
2. With motor ears flat to the rear of the top plate, rotate clockwise until mounting tabs are engaged in slots.
3. Reconnect wires.

The optical sensor is mounted to the top plate. The camshaft cup rotates through the sensor and the slots are detected. A signal is sent to the controller for each slot.



Damaged sensors should be replaced. Sensors may be cleaned with compressed air or a soft brush.

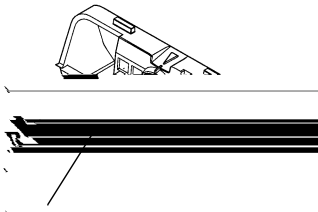

Do not bend the legs on the optical sensor

1. Disconnect power to the unit.
2. Remove cover.
3. Remove controller.
4. From the controller side, pinch the legs of the sensor holder in the top plate.
5. Pull the holder away from the mounting surface.
6. Remove wires.

1. Attach wires. Wires should point away from camshaft.
2. Place leading edge of sensor holder into opening.
3. Pivot holder into place. Legs should enter slots and snap in place.



W The optical sensor legs are fragile and may break. If the optical sensor legs break or crack, we recommend replacement. A damaged sensor may result in improper regeneration.

The camshaft has several lobes that push open the valve discs as the camshaft rotates. Rotation is controlled by a drive motor that drives a gear at the rear of the camshaft. The front end has a cup with markings and slots.



W The camshaft slots are molded to exact dimensions. Do not attempt to modify the cam cup slots. Improper regen will occur!

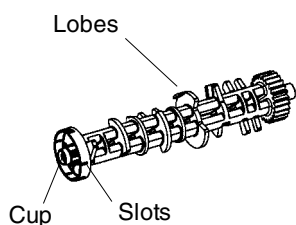

The outside surface of the cup has an arrow mark. When the arrow is at top center, the camshaft is in the loading position. 90 degrees clockwise on the cup an optical sensor is mounted to the top plate. This sensor reads the slots as they pass through. The largest slot is "Home" and the remaining slots are positioned to signal the regeneration cycles.

When looking at the end of the camshaft, numbers are visible in the hollow of the cup. An arrow on the top plate points to the current marking. The numbers represent regeneration cycles as follows:

- C0 = Treated water-normal operation mode
- C1 = Backwash
- C2 = Regenerant draw (not used in filter mode)
- C3 = Slow rinse (not used in filter mode)
- C4 = System pause
- C5 = Fast rinse cycle 1
- C6 = Backwash cycle 2 (not used in filter mode)
- C7 = Fast rinse cycle 2 (not used in filter mode)
- C8 = Regenerant refill (not used in filter mode)

These numbers are offset rotationally 90 degrees from the matching slot. The offset enables the service person to view the number at the top of the cup and determine which slot is at the optical sensor.



If any part of the camshaft is broken or damaged the camshaft should be replaced. Do not repair or modify damaged cam lobes, gears or timing cup.

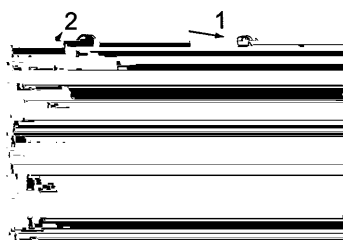

1. Disconnect power to the unit.
2. Remove cover.
3. Remove motor.
4. Camshaft should be in the treated water position. Rotate counterclockwise as needed.
5. Use a screwdriver to hold open the #1 valve disc.

6. Move the camshaft backwards, away from the controller.
7. Lift the loose front end up and out.

1. Check that the optical sensor is in position.
2. Position camshaft above the valve discs. The arrow on the cup should be up.

3.

4. Rotate the camshaft close to its final position.

5. The camshaft will push on one or more valve discs. You will feel resistance as it pushes the disc.

6. Move the camshaft to its final position. The camshaft will push on one or more valve discs. You will feel resistance as it pushes the disc.

W. 9

The wiring harnesses are designed to fit one way. The connectors are unique to the port they plug into. The wires are held in place by clips and the connectors latch in place.

Figure 18 - Wire Harness Routing

Do not run wires through holes in topplate.

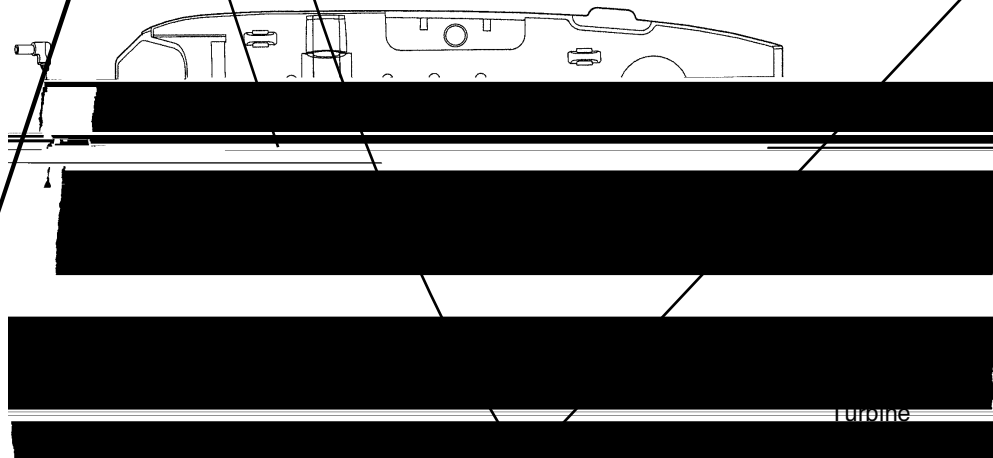

1. Disconnect power to the unit.
2. Remove cover.
3. Remove controller.
4. Remove connections by squeezing the latch on the connector and pulling out.
5. Pull the harness out of the clips on the top plate.

- 
1. Depending on which harness is being installed, plug the connector into the motor or turbine.
 2. Route the harness through the opening at the back of the top plate.
 3. Place the harness into the clips on the top plate. Do not leave any slack. Put the motor wire in first, then the turbine sensor cable second.



W - The Pentair Water valve is rated for low voltage (less than 48 volts) microswitch components only. Using a high voltage switch may result in damaged valves or fire and may interfere with electronic control function.

1. Disconnect power to the switch.
2. Remove cover.
3. Unscrew switch base from top plate.
4. Disconnect wires.

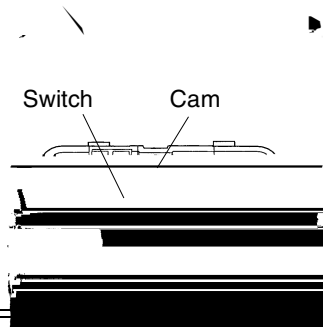

This microswitch is mounted behind the controller at the front end of the camshaft. The switch is mounted to the top plate. The cam for this switch is screwed to the front of the camshaft. This cam can be adjusted to activate the microswitch at any time during the regeneration cycle.

The front end cam switch is available as a kit from Pentair Water.



W - This switch will normally control an event on another piece of equipment. Be certain of what effect your actions will have on the other equipment.

5. Disconnect power to the switch.
6. Remove cover.
7. Remove controller.
8. Unscrew switch from top plate.
9. Disconnect wires.

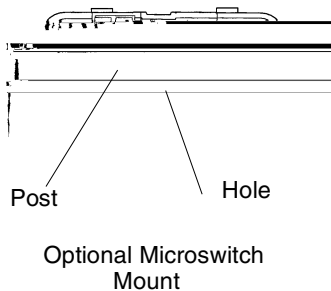

1. Connect wires.
2. Screw switch base to top plate using the switch guide pin over screw boss.
3. Attach the switch cam to front of the camshaft with a self-tapping screw. Adjust to the appropriate cycle and tighten.



- The cam for this switch is adjustable. To have the microswitch activate at a different point in the cycle, rotate the cam as needed. To rotate the cam loosen the center screw, tighten when the cam is in the new position.

1. Inspect the spring for damage. Do not attempt to repair a bent spring.

▶

The top plate holds the valve discs in place during operation. This plate is removed to allow cleaning and replacing the valve discs.

1. Disconnect power to unit.
2. Remove cover.
3. Remove motor.
4. Remove camshaft.
5. Place unit in bypass.
6. Release water pressure by pushing the last valve disc open with a screwdriver.
7. Any optional items may be removed.
8. Wiring harnesses should be removed.
9. Remove valve disc and spring.
10. Use a phillips screwdriver to remove the screws from the top plate.
11. Lift the top plate off. All the valve discs can be pulled straight out.

Inspect valve discs for wear. The sealing surface is the raised ridge on the underside of the top shoulder.

Check each valve disc cavity in the valve for debris. Remove any foreign objects before replacing the valve disc.



All valve discs should be in position. Use the same screws that were removed to reassemble the top plate.



W Follow the procedure to engage the screws with the existing threads. If the same threads are not used, the holding power of the screw is lost. Under pressure the valve can leak. Screws that have the same diameter but have different threads should not be used.

1. Position the top plate on top of the valve and over the valve discs.
2. Insert a screw at one of the corner positions.



W This procedure for reinserting screws must be followed to ensure proper holding strength of the screws.

- A. Drop screw of same size and thread into the hole.
- B. Use a phillips screwdriver and lightly rotate the screw backwards (counterclockwise).
- C. When the thread of the screw and the thread of the hole match, the screw will “click” and slightly drop down.
- D. The threads are lined up. Lightly rotate the screw to tighten and engage threads.
- E. Once the threads have engaged the screw can be tightened. Minimal resistance will be present as the screw is turned in. Resistance indicates new threads are being formed. Back the screw out and rematch the threads.

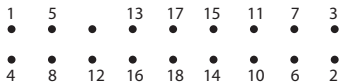

3. Turn the screw in but do not tighten.
4. Place a second screw into the hole diagonally opposite the first screw and turn in but do not tighten.
5. Insert another screw into one of the remaining corners and turn it in.
6. The fourth screw goes into the hole diagonally opposite. Turn it in.
7. Put the remaining screws in following the same criss-cross pattern working from the ends toward the center. When all the screws are in place they can be tightened down.
8. Start at the corner of the screw pattern and tighten that screw. Work the same pattern from the ends toward center and criss-crossing as each screw is tightened. Check that each valve disc moves smoothly before replacing the spring and camshaft.
9. Replace spring.
10. Replace camshaft and motor.
11. Replace controller and wiring harnesses.



1	1244650	255 Valve Assembly, w/o Flow Controls	1	16	1000269	Injector Cap with O-Ring	1
2	1033784	255 Tank Adapter New Style	1	17		Drain Control Assembly with O-Ring	1
3	1010429	O-Ring BN	1		1000209	No. 7 (1.3 gpm; 4.9 Lpm)	
4	1010428	O-Ring EP			1000210	No. 8 (1.7 gpm; 6.4 Lpm)	
5	1235340	Top Plate, 255 Valve, Logix Series Controller	1		1000211	No. 9 (2.2 gpm; 8.3 Lpm)	
6	1235341	Spring, One Piece, 255 Valve	1		1000212	No. 10 (2.7 gpm; 10.2 Lpm)	
7	1236246*	Cover, Valve, 255/Performa, Logix Series Controller	1		1002130	No. 12 (3.9 gpm; 14.76 Lpm)	
8	1001404	O-Ring Group: Tank Adapter	1	18A	1000214	No. 13 (4.5 gpm; 17 Lpm)	
9	1040459	O-Ring Group: Piping Boss	1	18B	1000215	No. 14 (5.3 gpm; 20 Lpm)	
10	1001986	13/16 inch Rubber Insert (Optional)	1	19	1000222	Regenerant Refill Controller, No Ball, 0.33 gal.	1
*	1000250	Valve Disk Kit - Standard	1		1243510	Regenerant Refill Controller	
*	1239760	Blending Valve Kit 900/700 Series	1			Air Check Kit	1
11		Locking Bar	1	20	1032416	Air Check Kit 3/8-inch male	
	1031402	English Language Locking Bar		21	1032417	Air Check Kit 1/4-inch male	
					1235373	Module, Sensor, Photo Interrupter	1
					1030502	Ball, Flow Control	1

*Not Shown

Part			Part				
Code	No.	Description	Qty.	Code	No.	Description	Qty.
1	1035807	Valve Assembly w/o Flow Controls	1		1035735	"K" Injector (High Efficiency) - Pink (12-inch tank)	
2	1235338	Top Plate, 268/700 Series Valves	1		1035736	"L" Injector (High Efficiency) - Orange (13 & 14-inch tanks)	
3	1235339	Valve Disc Spring, One Piece, Performa Valve	1		1032978	Plugged Injector for 263 Filter	
4	1236246	Cover, Valve, 255/Performa Logix Series Controller	1		1032985	Plugged Injector Cap	
5		Performa Logix Camshafts	1	10A	1000222	Regenerant Refill Controller, No Bal, 0.33 gpm	1
	1235352	Cam, 263-268/700 Series Valve, STD, Black		10B	1243510	Regenerant Refill Controller	
6		Drain Control Assembly:	1	11	1030502	Ball, Refill Flow Control	
	1000209	No. 7 (1.3 gpm; 4.9 Lpm)		*	1030334	Plugged Refill Flow Control - for 263 Valve	
	1000210	No. 8 (1.7 gpm; 6.4 Lpm)		12	1002449	Drain Fitting Elbow (3/4-inch hose barbed)	1
	1000211	No. 9 (2.2 gpm; 8.3 Lpm)		13	1010428	O-Ring	1
	1000212	No. 10 (2.7 gpm; 10.2 Lpm)		14	1000269	Injector Cap with O-Ring	1
	1000213	No. 12 (3.9 gpm; 14.76 Lpm)		15	1035622	Tank Ring	1
	1000214	No. 13 (4.5 gpm; 17 Lpm)		*	1041174	Valve Disc Kit: Standard	
	1000215	No. 14 (5.3 gpm; 20 Lpm)		16	Plumbing Adapter Kits:		1
	1239760	Blending Valve Kit 900/700 Series Top Plate			1001606	3/4-inch Copper Tube Adapter Kit	
*		Drain Line Flow Control (External)	1		1001670	1-inch Copper Tube Adapter Kit	
	1030355	Drain Line Flow Control, 5 gpm (19 Lpm)			1001608	22-mm Copper Tube Adapter Kit	
	1030356	Drain Line Flow Control, 6 gpm (22.5 Lpm)			1001613	3/4-inch CPVC Tube Adapter Kit	
	1030357	Drain Line Flow Control, 7 gpm (26.5 Lpm)			1001614	1-inch CPVC Tube Adapter Kit	
	1030358	Drain Line Flow Control, 8 gpm (30 Lpm)			1001615	25-mm CPVC Tube Adapter Kit	
	1030359	Drain Line Flow Control, 9 gpm (34 Lpm)			1001769	3/4-inch NPT Plastic Pipe Adapter Kit	
	1030360	Drain Line Flow Control, 10 gpm (38 Lpm)			1001603	1-inch NPT Plastic Pipe Adapter Kit	
7	1235361	Motor/Optical Cable Assembly	1		1001604	3/4-inch BSPT Plastic Pipe Adapter Kit	
					1001605	1-inch BSPT Plastic Pipe Adapter Kit	

*Not shown on drawing.

9K 00

00

B

00

9

ERR 1 is displayed	Controller power has been connected and the control is not sure of the state of the operation.	Press the UP arrow and the control should reset.
ERR 2 is displayed	Controller power does not match 50 or 60 Hz.	Disconnect and reconnect the power. If problem persists, obtain the appropriate controller or AC adapter for either 50 or 60 Hz power.
ERR 3 is displayed	Controller does not know the position of the camshaft. Camshaft should be rotating to find Home position.	Wait for two minutes for the controller to return to Home position. The hourglass should be flashing on the display indicating the motor is running.
	Camshaft is not turning during ERR 3 display.	Check that motor is connected. Verify that motor wire harness is connected to motor and controller module. Verify that optical sensor is connected and in place. Verify that motor gear has engaged cam gear. If everything is connected, try replacing in this order: <ul style="list-style-type: none">—Wire harness—Motor—Optical sensor—Controller
	If camshaft is turning for more than five minutes to find Home position:	Verify that optical sensor is in place and connected to wire. Verify that camshaft is connected appropriately. Verify that no dirt or rubbish is clogging any of the cam slots. If motor continues to rotate indefinitely, replace the following components in this order: <ul style="list-style-type: none">—Wire harness—Motor—Optical sensor—Controller
Four dashes displayed: — — : — —	Power failure occurred	Press SET to reset the time display.

- | | | |
|---|---|---|
| <p>11. Backwashes or purges at excessively low or high rate.</p> | <p>a. Incorrect drain controller used.</p> <p>b. Foreign matter affecting valve operation.</p> | <p>a. Replace with correct size controller. (Contact dealer.)</p> <p>b. Remove drain controller and clean ball and seat.</p> |
| <p>12. No water flow display when water is flowing on 760 controller.</p> | <p>a. Bypass valve in bypass.</p> <p>b. Meter probe disconnected or not fully connected to meter housing.</p> <p>c. Restricted meter turbine rotation due to foreign material in meter.</p> | <p>a. Shift bypass valve to not-in-bypass position.</p> <p>b. Fully insert probe into meter housing.</p> <p>c. Remove meter housing, free up turbine and flush with clean water. Turbine should spin freely. If not, replace meter. (Contact dealer.)</p> |
| <p>13. Run out of conditioned water between</p> | | |
| <p>ectec.27 -1.01cnbe icta.ti25.3(o)052(r)-63()47.3(p0.011 on.)]TJ17</p> | | |